

# Sleeping shelter 40 big (304x238) 2021

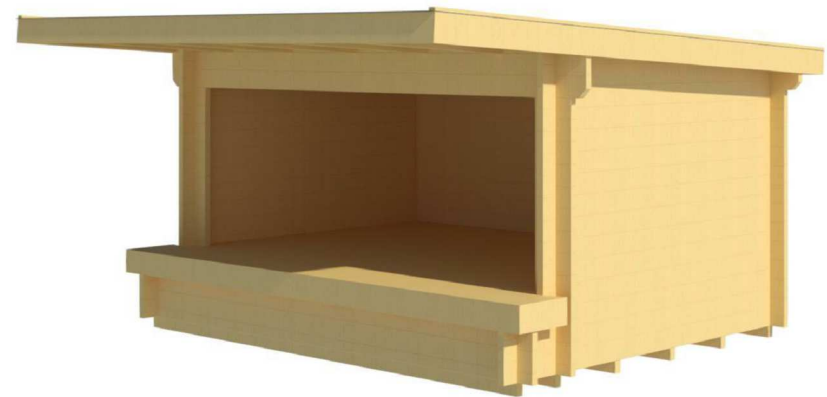

# Sleeping shelter 40 big (304x238) 2021

Foundation

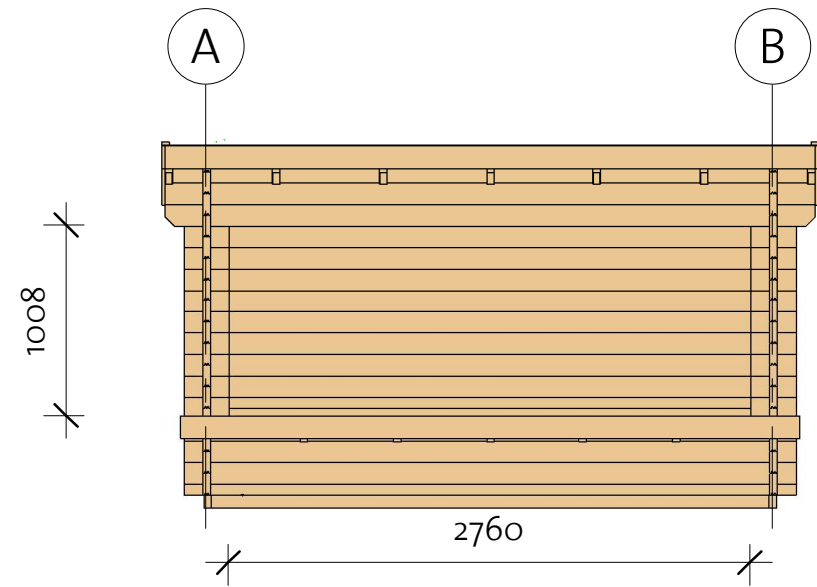
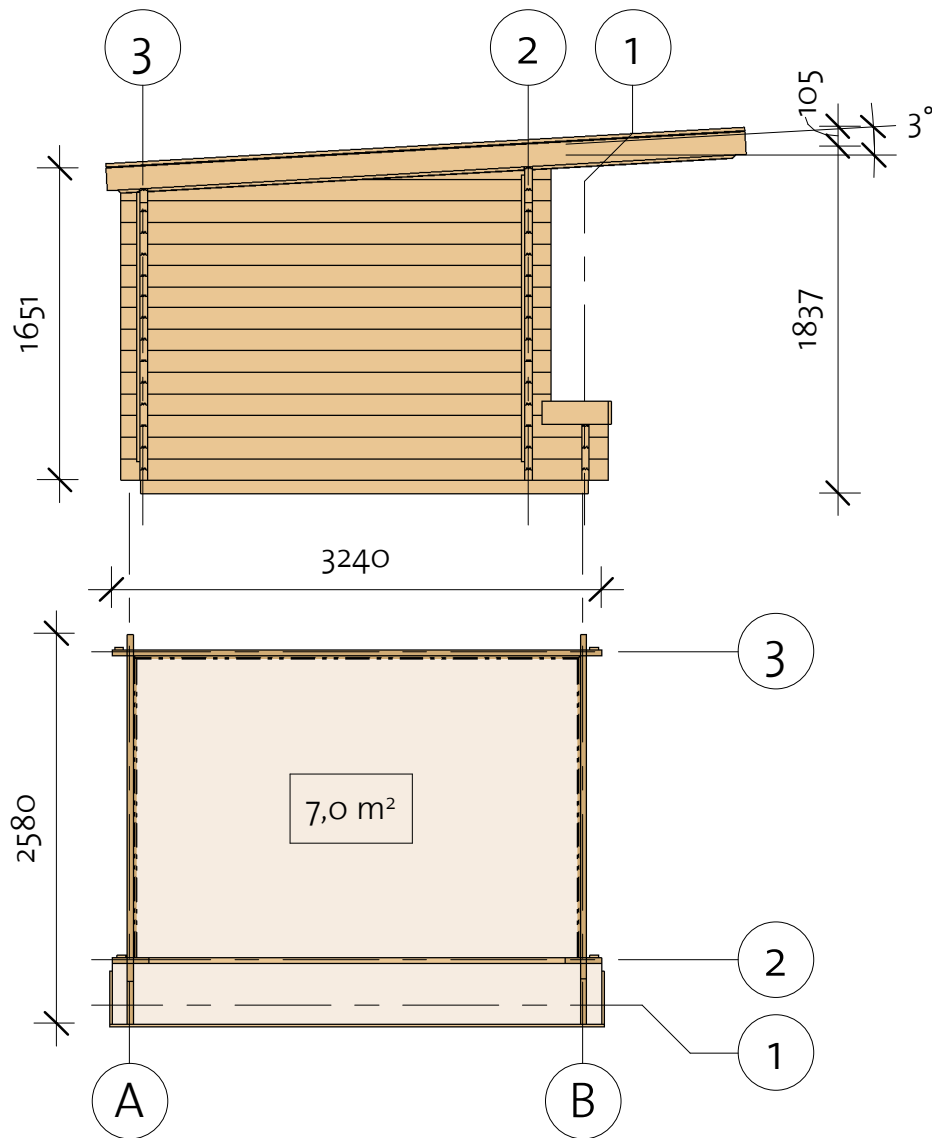
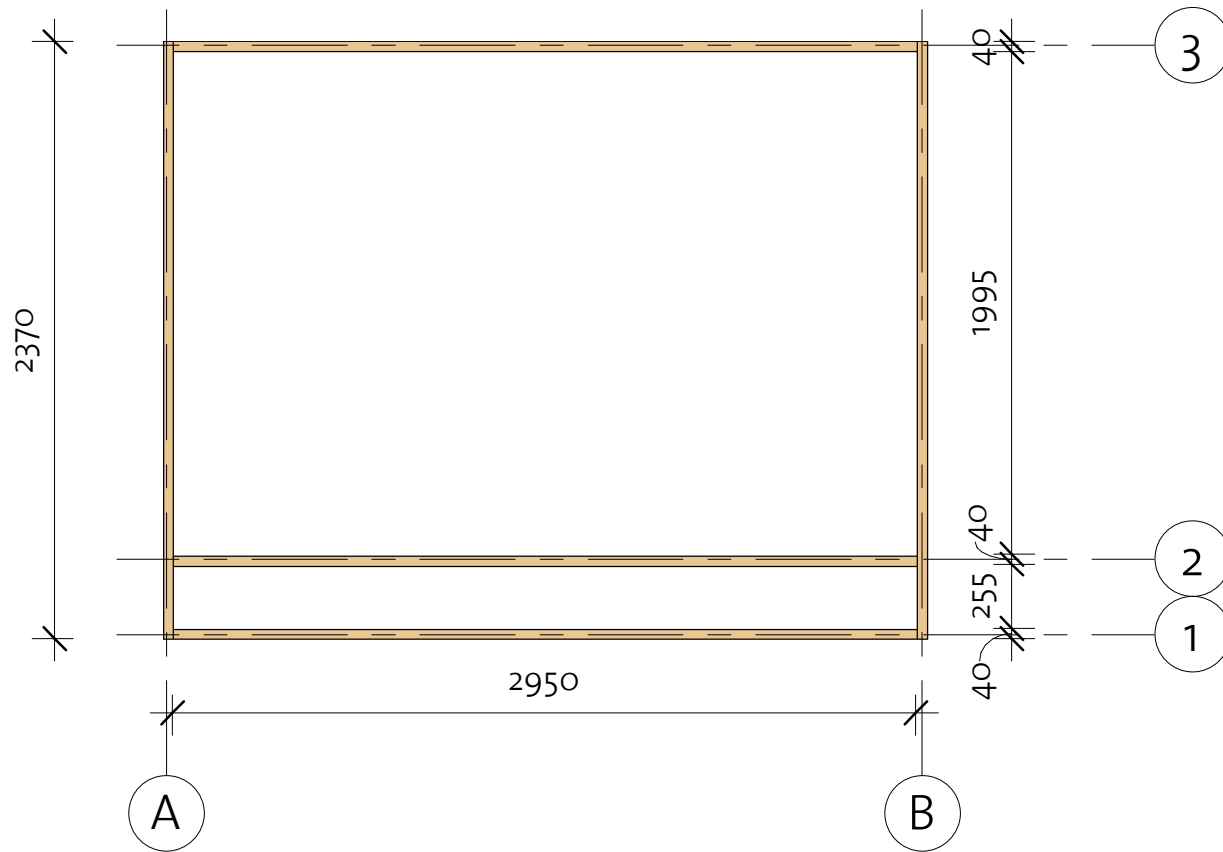

Impregnated foundation beams				
Mark	Type	Profile	Count	Length
IFB1	IFB 40x70		3	2950
IFB2	IFB 40x70		2	2370

# Sleeping shelter 40 big (304x238) 2021



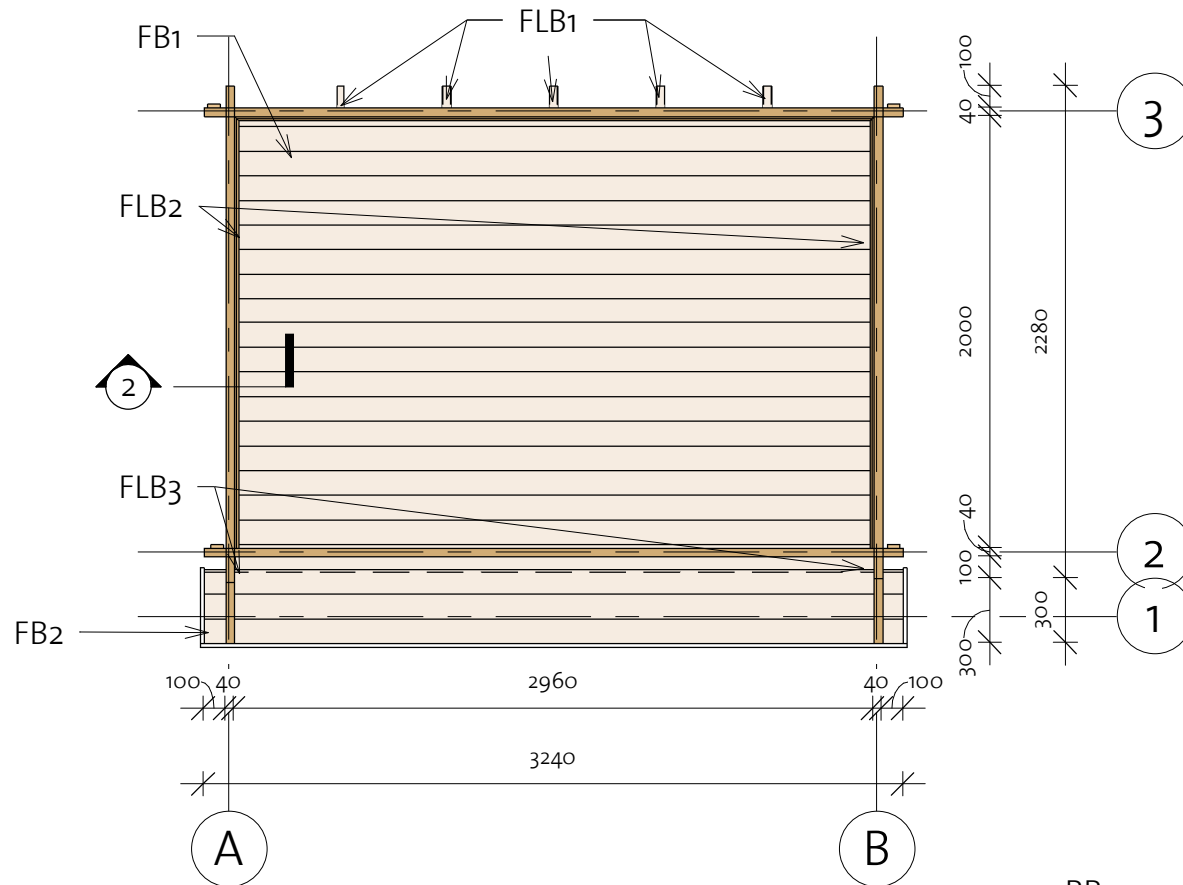

Floor Plan

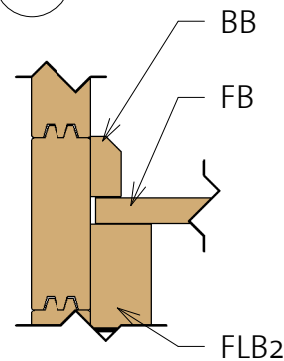

BB1	BB 20X40		1	3000
BB2	BB 20X40		2	2000



Floor Schedule

Mark	Type	Profile	Count	Length
FB1	FB 17x114		20	2957
FB2	FB 17x114		3	3240
FLB1	Floor beam 40x120		5	2580
FLB2	Floor beam 40x70		2	1960
FLB3	Floor beam 40x70		2	260

# Sleeping shelter 40 big (304x238) 2021

Wall 1

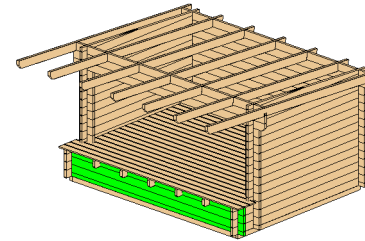

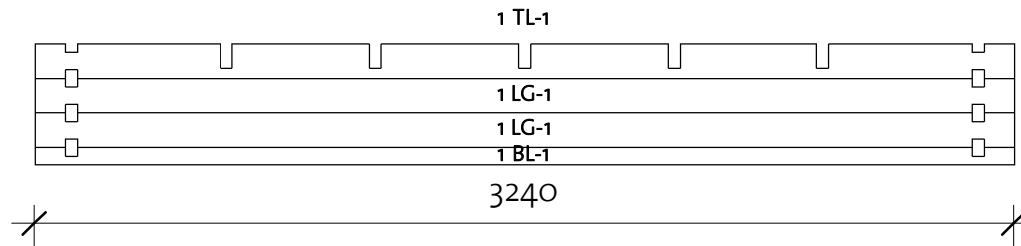

Wall 1			
Mark	Profile	Count	Cut Length

1BL-1	40X57	1	3240
1LG-1	40X114	2	3240
1TL-1	40X114	1	3240

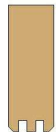

Log Profile Wall 1	
Profile	Profile

40X57	
40X114	
40X114	

# Sleeping shelter 40 big (304x238) 2021

Wall 2

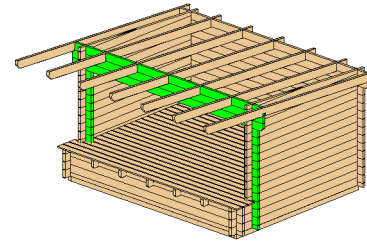

Wall 2			
Mark	Profile	Count	Cut Length

2BL-1	40X57	1	3240
2LG-1	40X114	18	240
2LG-2	40X114	2	3240
2LG-3	40X114	1	3240
2LG-4	40X114	1	3440
2LG-5	40X114	1	3440
2TL-1	40X114	1	3440

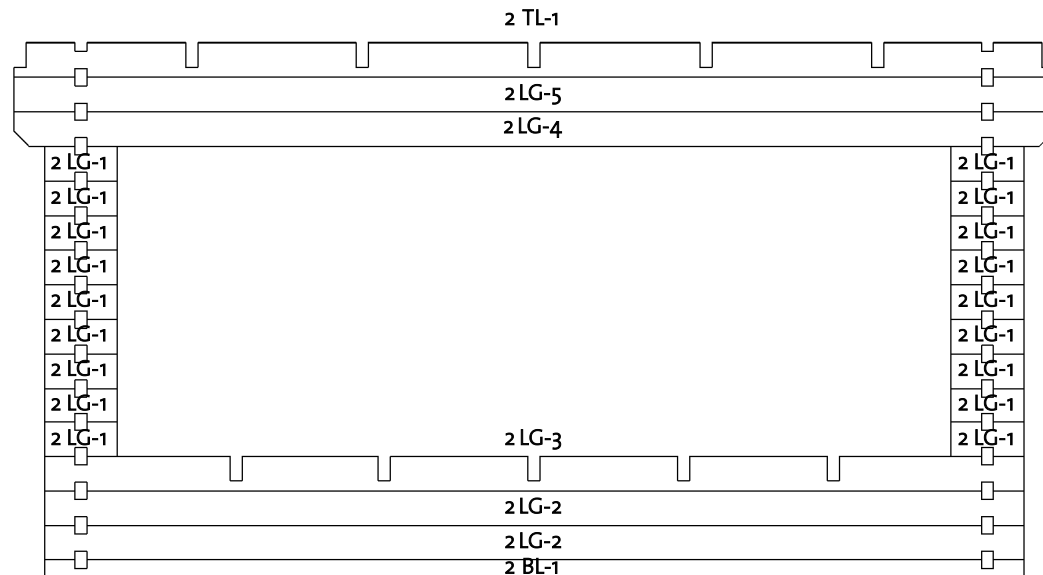

Log Profile Wall 2	
Profile	Profile

40X57	
40X114	
40X114	

# Sleeping shelter 40 big (304x238) 2021

Wall 3

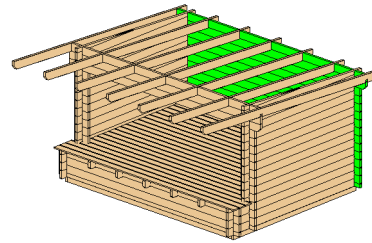

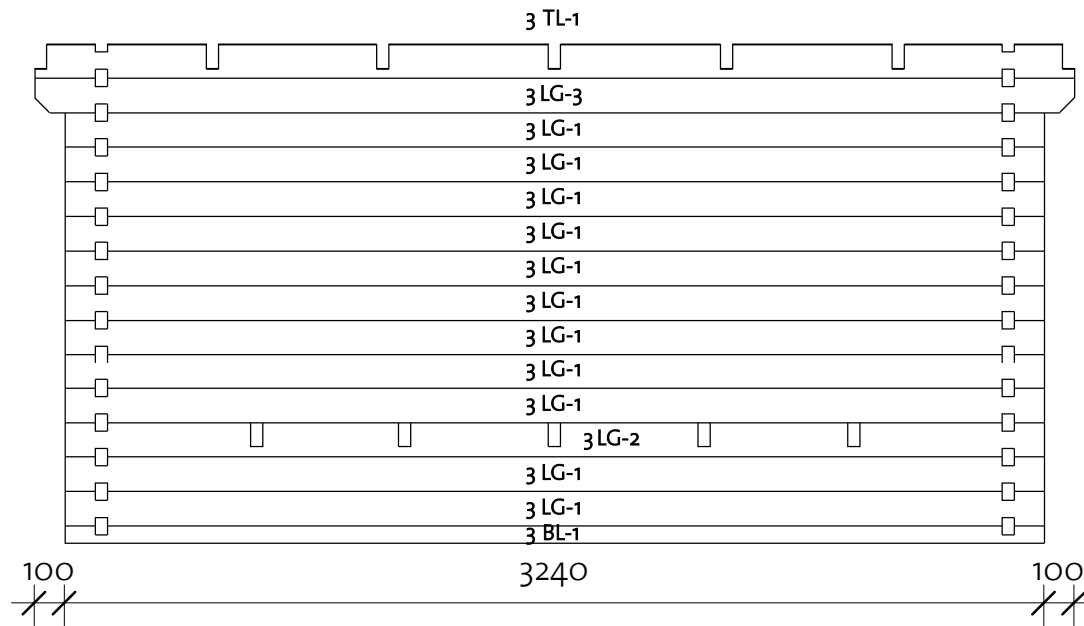

Wall 3			
Mark	Profile	Count	Cut Length
3BL-1	40x57	1	3240
3LG-1	40x114	11	3240
3LG-2	40x114	1	3240

Wall 3			
Mark	Profile	Count	Cut Length
3LG-3	40x114	1	3440
3TL-1	40x112	1	3440



Log Profile Wall 3	
Profile	Profile

40x57	
40x114	
40x112	

# Sleeping shelter 40 big (304x238) 2021

Wall A

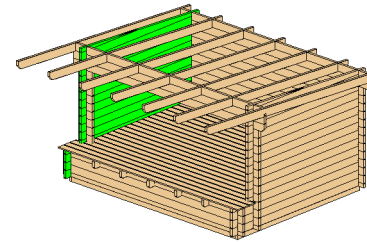

Wall A			
Mark	Profile	Count	Cut Length

ALG-1*	40x114	1	1100
ALG-2*	40x114	1	2280
ALG-3	40x114	10	2280
ALG-4	40x114	1	2580
ALG-5	40x114	3	2580

\* Gable - delivered premounted

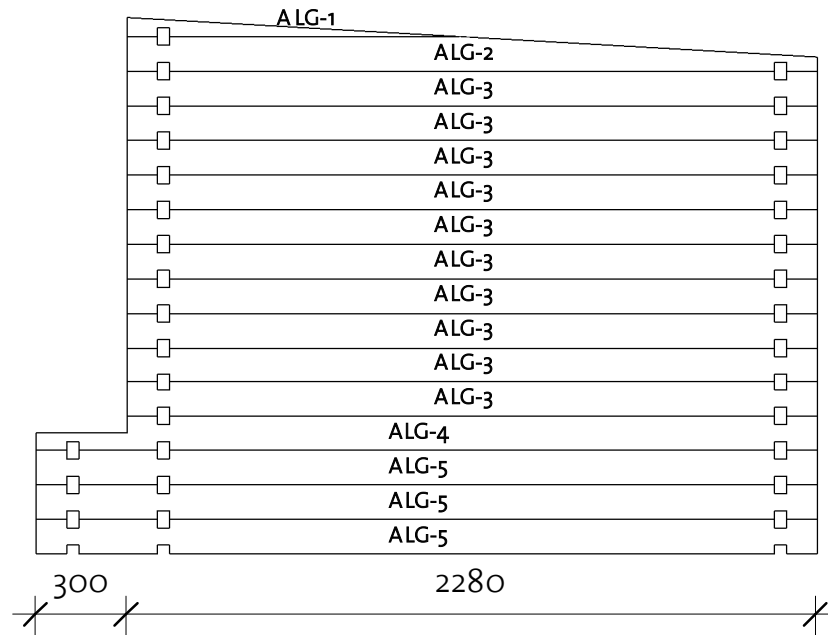

Log Profile Wall A	
Profile	Profile

40x114	
--------	--

# Sleeping shelter 40 big (304x238) 2021

Wall B

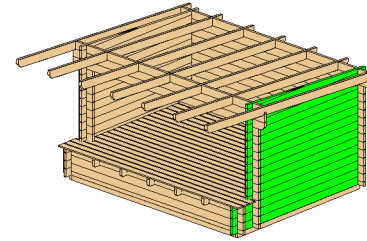

Wall B			
Mark	Profile	Count	Cut Length

BLG-1*	40x114	1	1100
BLG-2*	40x114	1	2280
BLG-3	40x114	10	2280
BLG-4	40x114	1	2580
BLG-5	40x114	3	2580

\* Gable - delivered premounted

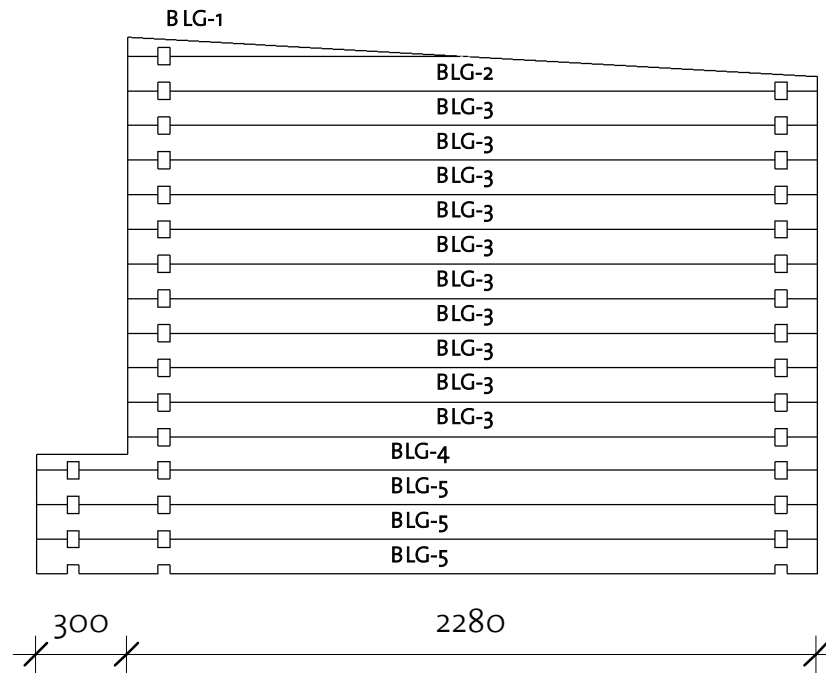

Log Profile Wall B	
Profile	Profile

40x114	
--------	--





# Sleeping shelter 40 big (304x238) 2021

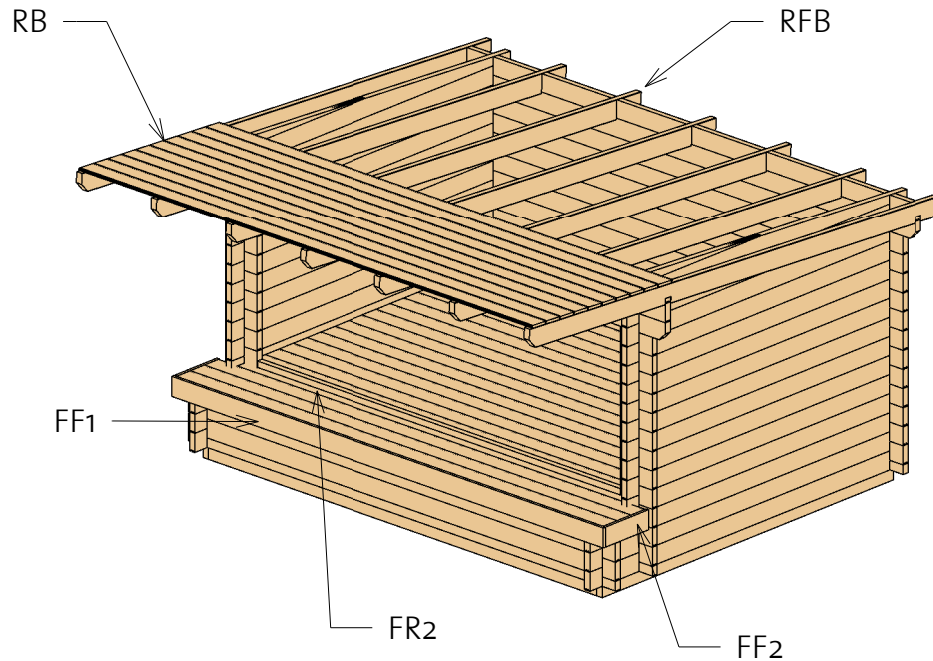

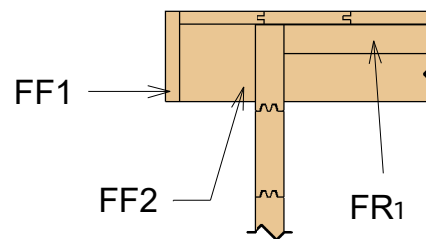

Roof 1



① Floor Fascia





Roof				
Mark	Type	Profile	Count	Length
RFB	Beam 40x120		7	3350
RB	17x114		31	3440

Floor Fascia				
Mark	Type	Profile	Count	Length
FF1	Floor Fascia 18x120		1	3276
FF2	Floor Fascia 18x120		2	350
FR1	Floor reinforcement 38x38		2	190
FR2	Floor reinforcement 38x38		1	2760

# Sleeping shelter 40 big (304x238) 2021

Roof 2

Fascia Schedule				
Mark	Type	Profile	Count	Length

EE	Eave Edging 18x40		2	3386
RF1	Roof Fascia 18x120		2	3386
RF2	Roof Fascia 18x120		2	3440

## ③ Facia

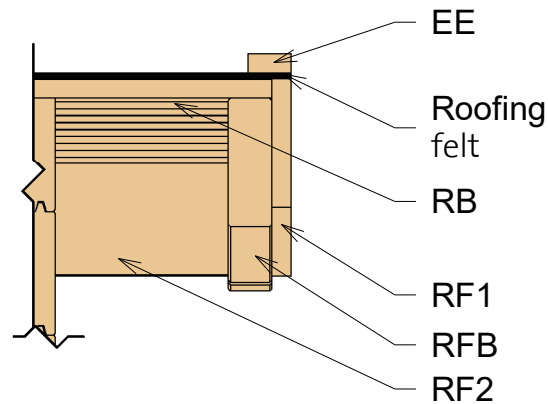
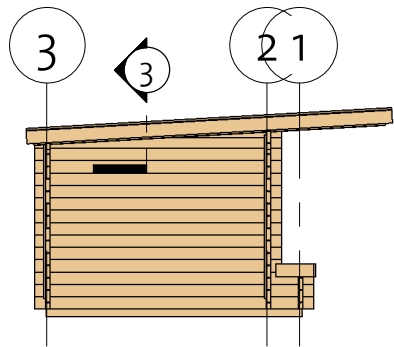

## ④ Roof Reinforcement

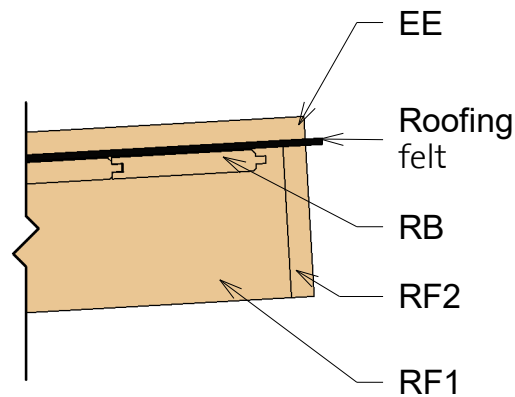
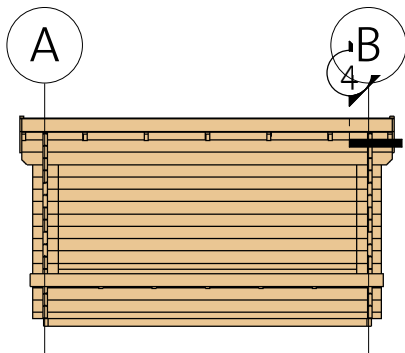

# Sleeping shelter 40 big (304x238) 2021

Extras

Fasteners/Extras		
Name	Type	Count

Hitblock	300-400 mm	
Bolts	M8x70	12
Nails	1,4 x 40	20
Screws	5,0x 70	35
Screws	6,0 x 140	50
Screws	4,0 x 40	55
Screws	4,0 x 50	450









Type	Count	Length
------	-------	--------

Windboard 18x40	2	1520
Windboard 18x40	2	1650

# Sleeping shelter 40 big (304x238) 2021

## List of all items 1

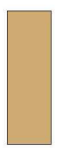
Roof				
Mark	Type	Profile	Count	Length
RFB	Beam 40x120		7	3350
RB	17x114		31	3440



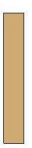
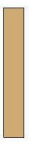

Floor Schedule				
Mark	Type	Profile	Count	Length
FB1	FB 17x114		20	2957
FB2	FB 17x114		3	3240
FLB1	Floor beam 40x120		5	2580
FLB2	Floor beam 40x70		2	1960
FLB3	Floor beam 40x70		2	260

Fascia Schedule				
Mark	Type	Profile	Count	Length
EE	Eave Edging 18x40		2	3386
RF1	Roof Fascia 18x120		2	3386
RF2	Roof Fascia 18x120		2	3440



# Sleeping shelter 40 big (304x238) 2021

## List of all items 2

Floor Fascia				
Mark	Type	Profile	Count	Length

FF1	Floor Fascia 18x120		1	3276
FF2	Floor Fascia 18x120		2	350
FR1	Floor reinforcement 38x38		2	190
FR2	Floor reinforcement 38x38		1	2760

Impregnated foundation beams				
Mark	Type	Profile	Count	Length

IFB1	IFB 40x70		3	2950
IFB2	IFB 40x70		2	2370

BB1	BB 20x40		1	3000
BB2	BB 20x40		2	2000

# Sleeping shelter 40 big (304x238) 2021

## List of all items 3

Wall 1			
Mark	Profile	Count	Cut Length

1BL-1	40X57	1	3240
1LG-1	40X114	2	3240
1TL-1	40X114	1	3240



Wall 2			
Mark	Profile	Count	Cut Length

2BL-1	40X57	1	3240
2LG-1	40X114	18	240
2LG-2	40X114	2	3240
2LG-3	40X114	1	3240
2LG-4	40X114	1	3440
2LG-5	40X114	1	3440
2TL-1	40X114	1	3440

Wall 3			
Mark	Profile	Count	Cut Length

3BL-1	40X57	1	3240
3LG-1	40X114	11	3240
3LG-2	40X114	1	3240

Log Profiles	
Profile	Profile

40X57	
40X112	

Wall A			
Mark	Profile	Count	Cut Length

ALG-1*	40X114	1	1100
ALG-2*	40X114	1	2280
ALG-3	40X114	10	2280
ALG-4	40X114	1	2580
ALG-5	40X114	3	2580

Wall B			
Mark	Profile	Count	Cut Length



BLG-1*	40X114	1	1100
BLG-2*	40X114	1	2280
BLG-3	40X114	10	2280
BLG-4	40X114	1	2580
BLG-5	40X114	3	2580

\* Gable - delivered premounted

Wall 3			
Mark	Profile	Count	Cut Length

3LG-3	40X114	1	3440
3TL-1	40X112	1	3440

Log Profiles	
Profile	Profile

40X114	
40X114	

Log Profiles	
Profile	Profile

40X114	
--------	---